

M O S A I C O S

**SAFONT**

CATÁLOGO DE SERVICIOS



Mosaicos Sfont S.L.  
Pol. Les Forques - Cno. Alcora, 103 - Apdo. 110  
Tel. 964 565 336 - Fax 964 565 337  
12550 Almazora (Castellón)  
España  
[pedidos@mosaicofont.com](mailto:pedidos@mosaicofont.com)  
[info@mosaicofont.com](mailto:info@mosaicofont.com)  
[www.mosaicofont.com](http://www.mosaicofont.com)

M O S A I C O S

**SAFONT**

C A T Á L O G O D E S E R V I C I O S

# ÍNDICE



PG. 2	PIEZAS
PG. 4	PELDAÑO ROMO
PG. 6	PELDAÑO DOBLE ROMO
PG. 8	PELDAÑO ROMO ESPESORADO 2CM
PG. 10	PELDAÑO INGLETADO
PG. 12	PELDAÑO DOBLE INGLETADO
PG. 14	PELDAÑO INGLETADO ESPESORADO 2CM
PG. 16	PELDAÑO CON TABICA
PG. 18	ENCIMERAS
PG. 20	BORDE DE PISCINA
PG. 22	SERVICIO DE CORTE

RODAPIE RECTO BISELADO

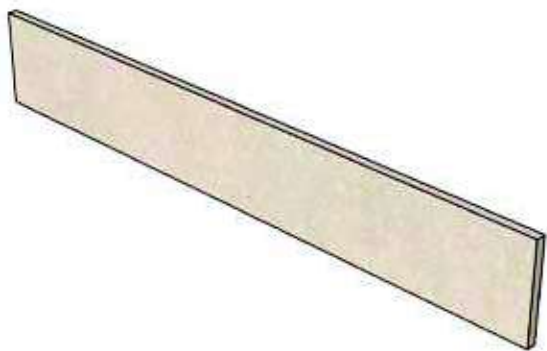

RODAPIE ROMO

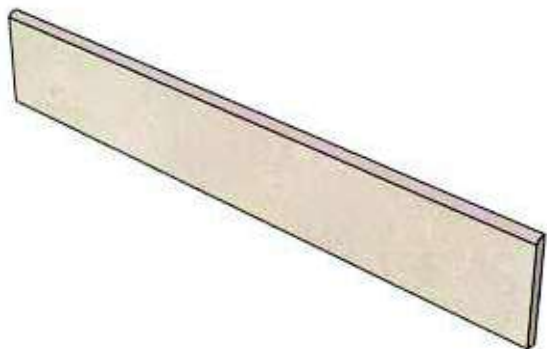

MALLA 5X5

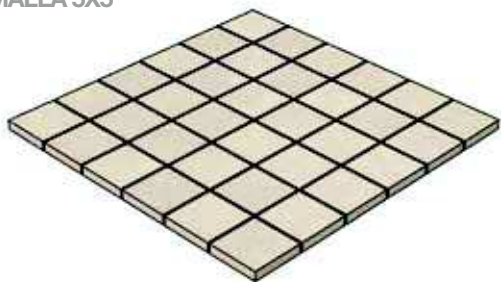

MALLA 2.5X2.5



ZANQUÍN (JUEGO DOS PIEZAS)

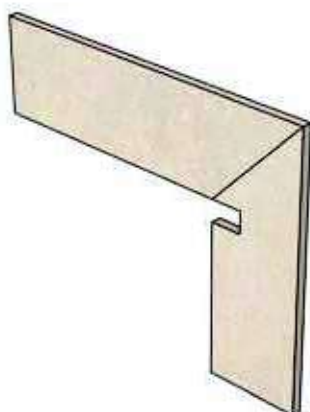

ESPESORADO (SANDWICH)



TRATAMIENTO ANTIDESLIZANTE C-2 O C-3

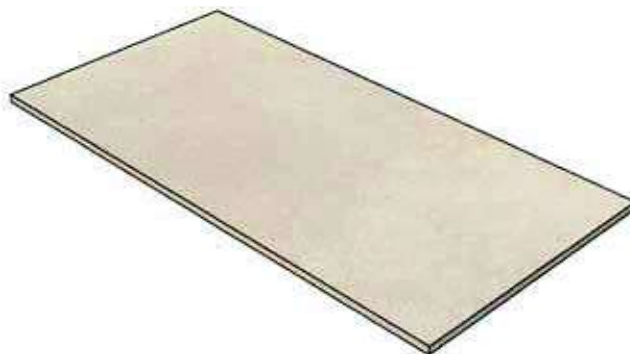

INGLETE

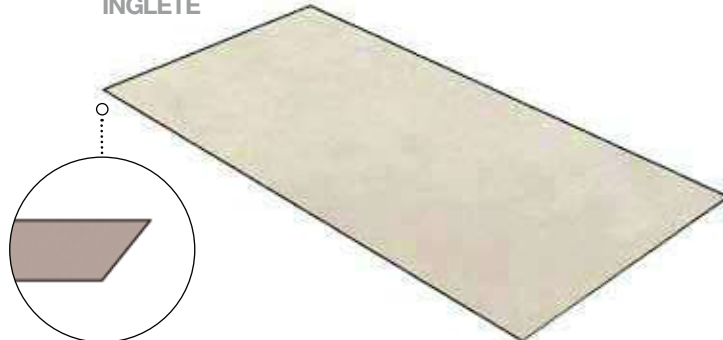

CORTE

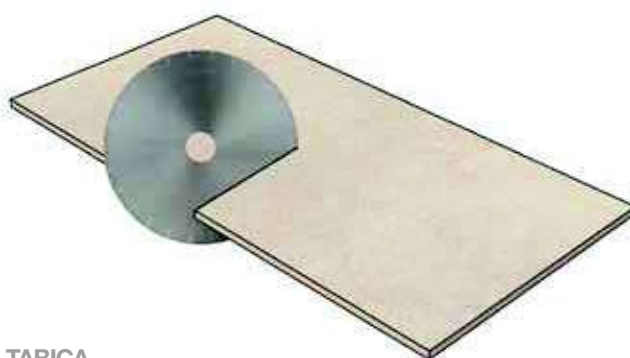

TABICA

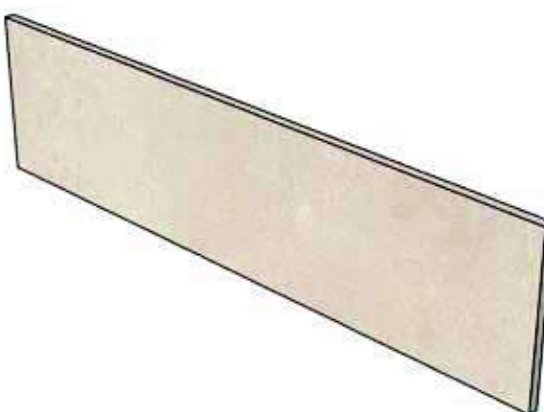

# PIEZAS



CORTE DE PIEZAS  
BASE 60X120  
30X120  
20X120



MALLA 2.5X2.5

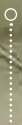

RODAPIE





# PELDAÑO ROMO



PELDAÑO ROMO S/H



PELDAÑO ANGULAR ROMO S/H IZQ. O DER.

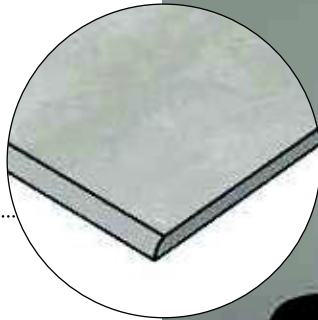

PELDAÑO ROMO C/H

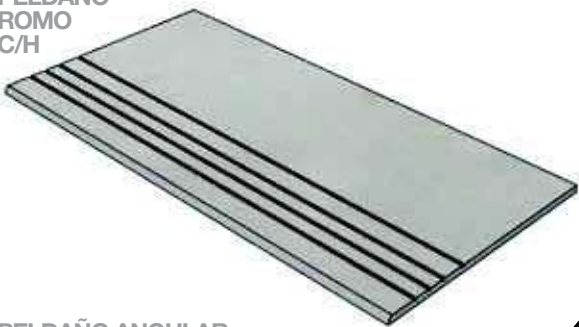

PELDAÑO ANGULAR ROMO C/H IZQ. O DER.

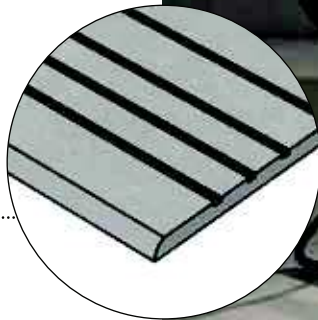
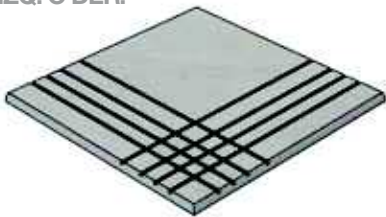

PELDAÑO ROMO CON VIERTEAGUAS



TABICA (CORTE A MEDIDA)

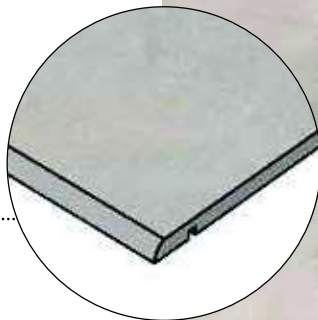
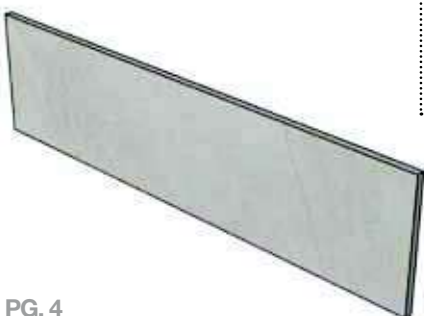



PELDAÑO  
ROMO CON  
VIERTEGUAS

PELDAÑO ANGULAR  
ROMO C/H

PELDAÑO ROMO C/H

TABICA

PELDAÑO ANGULAR ROMO S/H

PELDAÑO ROMO S/H



PELDAÑO DOBLE  
ROMO  
S/H

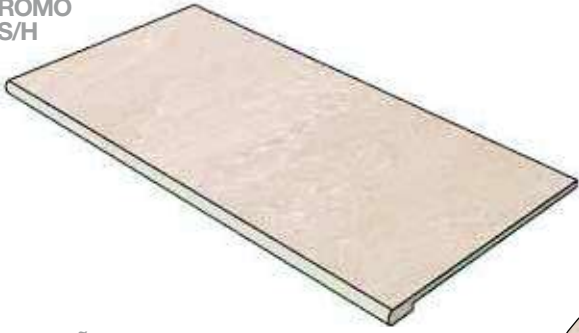

PELDAÑO DOBLE  
ROMO ANGULAR S/H  
IZQ. O DER.

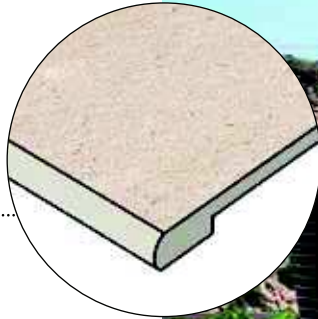

PELDAÑO DOBLE  
ROMO  
C/H

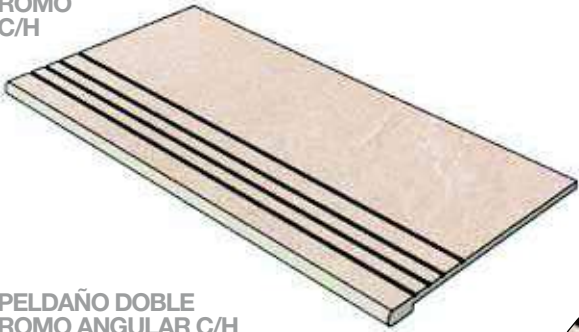

PELDAÑO DOBLE  
ROMO ANGULAR C/H  
IZQ. O DER.

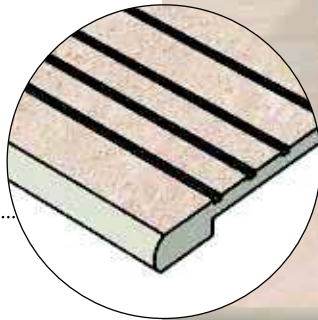
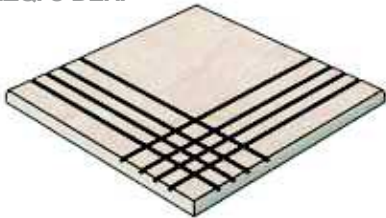

PELDAÑO DOBLE ROMO  
CON VIERTEAGUAS

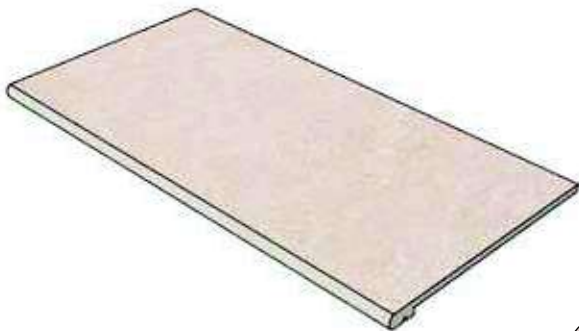

TABICA (CORTE A MEDIDA)

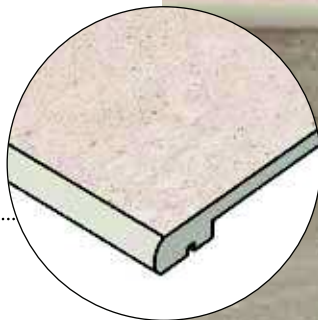

# PELDAÑO DOBLE ROMO

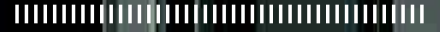

PELDAÑO DOBLE ROMO  
CON VIERTEAGUAS

PELDAÑO DOBLE ROMO S/H

PELDAÑO DOBLE  
ROMO ANGULAR S/H

TABICA

PELDAÑO DOBLE ROMO C/H

PELDAÑO DOBLE  
ROMO ANGULAR C/H



PELDAÑO ROMO  
ESPESORADO  
2CM S/H



PELDAÑO ROMO ANGULAR  
ESPESORADO 2CM S/H  
IZQ. O DER.

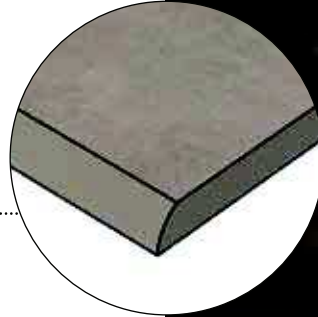
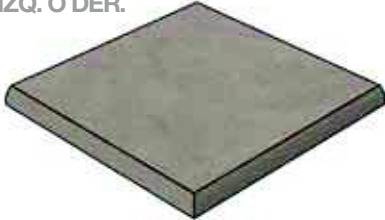

PELDAÑO ROMO  
ESPESORADO  
2CM C/H



PELDAÑO ROMO ANGULAR  
ESPESORADO 2CM C/H  
IZQ. O DER.

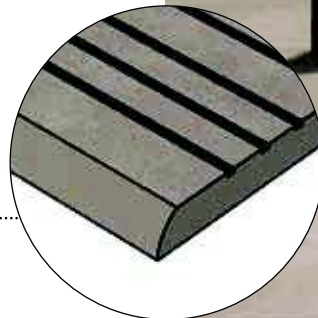

PELDAÑO ROMO ESPESORADO 2CM  
CON VIERTEAGUAS



TABICA (CORTE A MEDIDA)

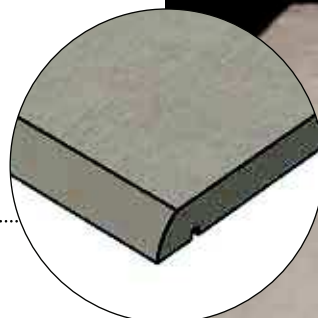
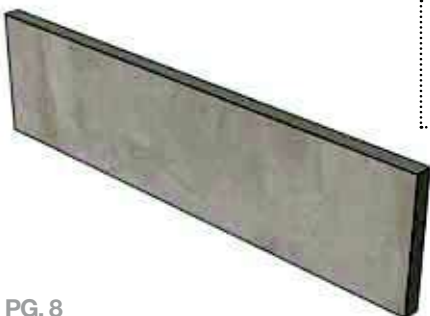

PELDAÑO ROMO  
ESPESORADO 2CM  
CON VIERTEAGUAS



# PELDAÑO ROMO ESPESORADO 2CM



PELDAÑO ROMO  
ESPESORADO  
2CM C/H

PELDAÑO ROMO ANGULAR  
ESPESORADO 2CM C/H

PELDAÑO ROMO  
ESPESORADO  
2CM S/H

TABICA

PELDAÑO ROMO ANGULAR  
ESPESORADO 2CM S/H



PELDAÑO INGLETADO S/H

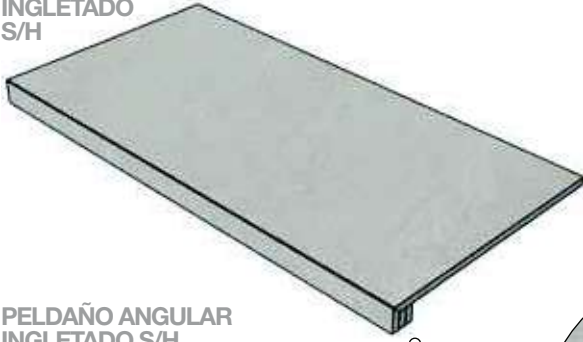

PELDAÑO ANGULAR INGLETADO S/H IZQ. O DER.

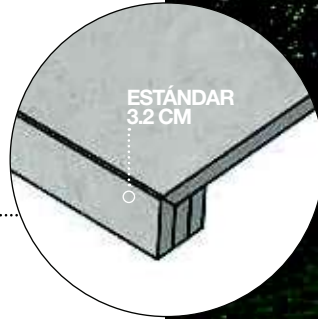

PELDAÑO INGLETADO C/H

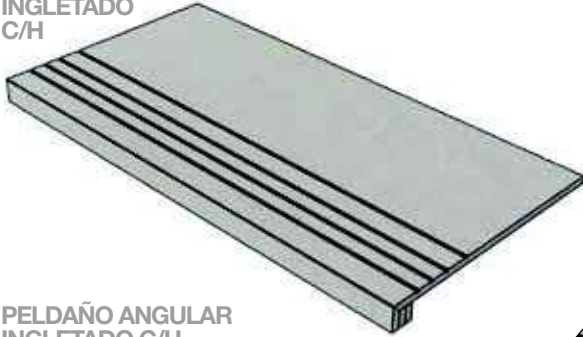

PELDAÑO ANGULAR INGLETADO C/H IZQ. O DER.

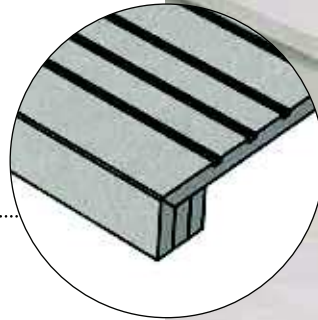
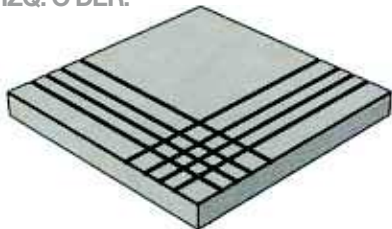

PELDAÑO INGLETADO CON VIERTEGUAS

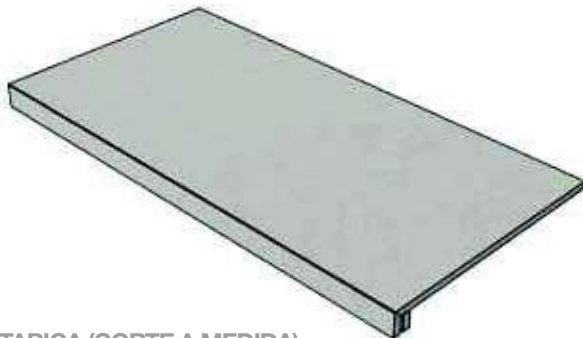

TABICA (CORTE A MEDIDA)

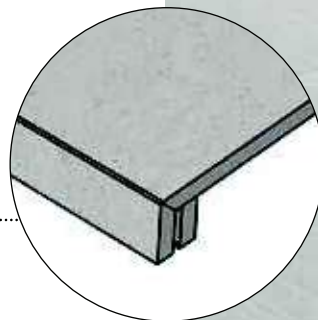
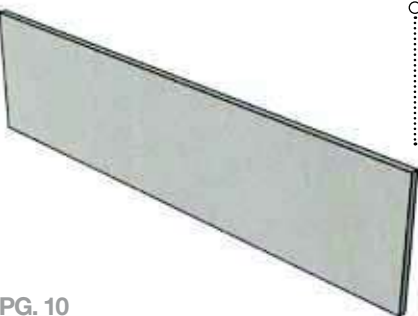

PELDAÑO INGLETADO CON VIERTEGUAS



# PELDAÑO INGLETADO



TABICA

PELDAÑO ANGULAR  
INGLETADO C/H

PELDAÑO INGLETADO C/H

PELDAÑO ANGULAR  
INGLETADO S/H

PELDAÑO INGLETADO S/H

PELDAÑO DOBLE  
INGLETADO  
S/H



PELDAÑO DOBLE  
INGLETADO ANGULAR S/H  
IZQ. O DER.

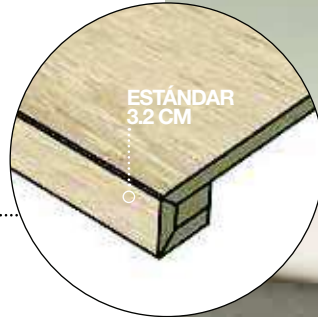

PELDAÑO DOBLE  
INGLETADO  
C/H

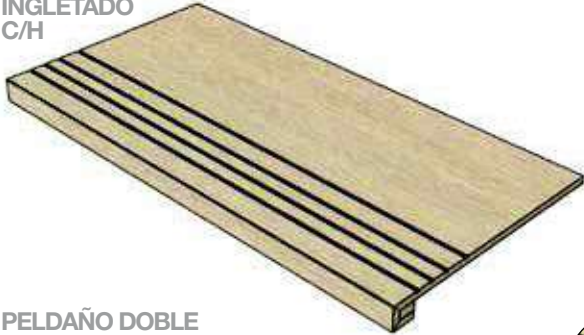

PELDAÑO DOBLE  
INGLETADO ANGULAR C/H  
IZQ. O DER.

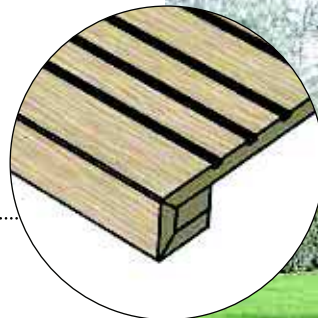
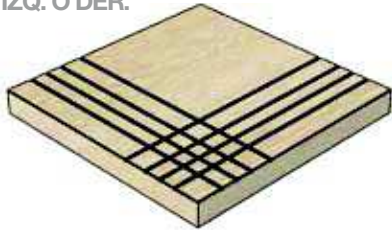

PELDAÑO DOBLE INGLETADO  
CON VIERTEAGUAS



TABICA (CORTE A MEDIDA)

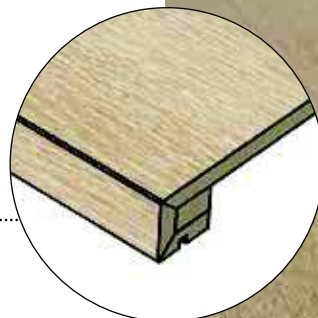
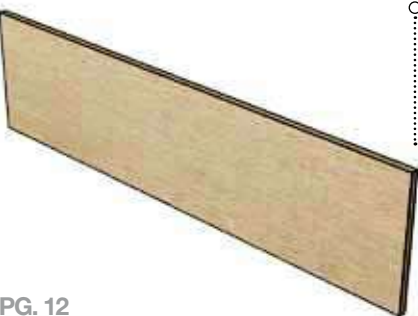

RODAPIE



# PELDAÑO DOBLE INGLETADO



TABICA

ZANQUÍN

PELDAÑO DOBLE INGLETADO S/H

PELDAÑO DOBLE INGLETADO ANGULAR S/H

PELDAÑO DOBLE INGLETADO C/H

PELDAÑO DOBLE INGLETADO ANGULAR C/H



PELDAÑO INGLETADO  
ESPESORADO  
2CM S/H



PELDAÑO INGLETADO  
ANGULAR ESPESORADO 2CM S/H  
IZQ. O DER.

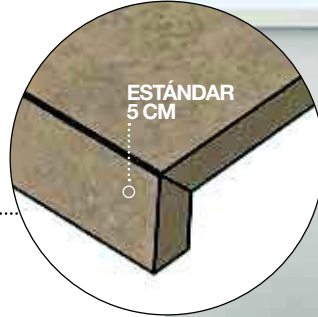

ESTÁNDAR  
5 CM

PELDAÑO INGLETADO  
ESPESORADO  
2CM C/H

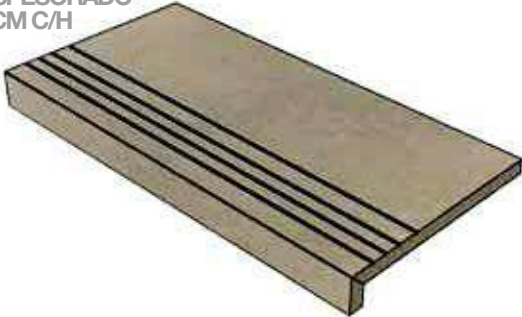

PELDAÑO INGLETADO  
ANGULAR ESPESORADO 2CM C/H  
IZQ. O DER.

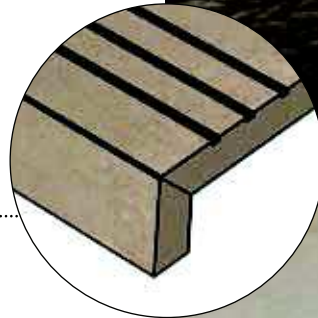
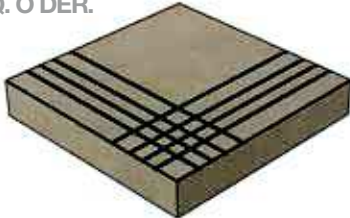

PELDAÑO INGLETADO  
ESPESORADO 2CM  
CON VIERTEAGUAS

PELDAÑO INGLETADO ESPESORADO 2CM  
CON VIERTEAGUAS



TABICA (CORTE A MEDIDA)

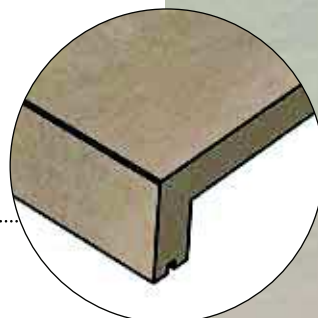

# PELDAÑO INGLETADO ESPESORADO 2CM



○..... PELDAÑO INGLETADO  
ESPESORADO 2CM C/H

○..... PELDAÑO INGLETADO  
ANGULAR ESPESORADO 2CM C/H

○..... PELDAÑO INGLETADO  
ANGULAR ESPESORADO 2CM S/H

○..... PELDAÑO INGLETADO  
ESPESORADO 2CM S/H

○.....  
TABICA



PELDAÑO  
CON TABICA  
S/H

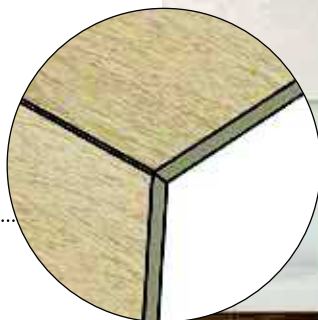

PELDAÑO ANGULAR  
CON TABICA S/H  
IZQ. O DER.



PELDAÑO  
CON TABICA  
C/H

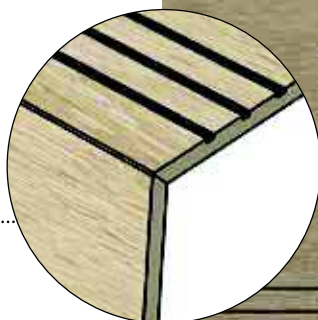
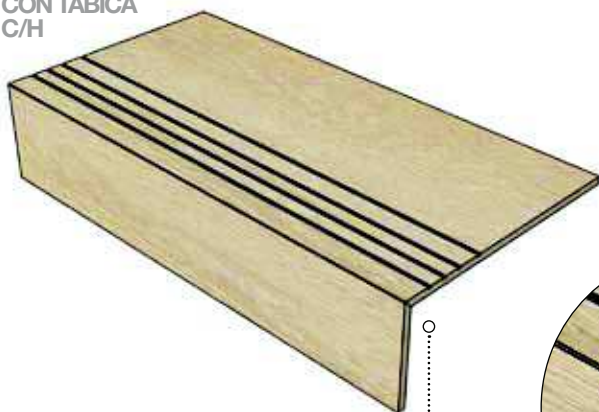

PELDAÑO ANGULAR  
CON TABICA C/H  
IZQ. O DER.

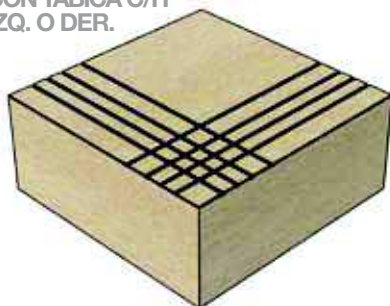



# PELDAÑO CON TABICA

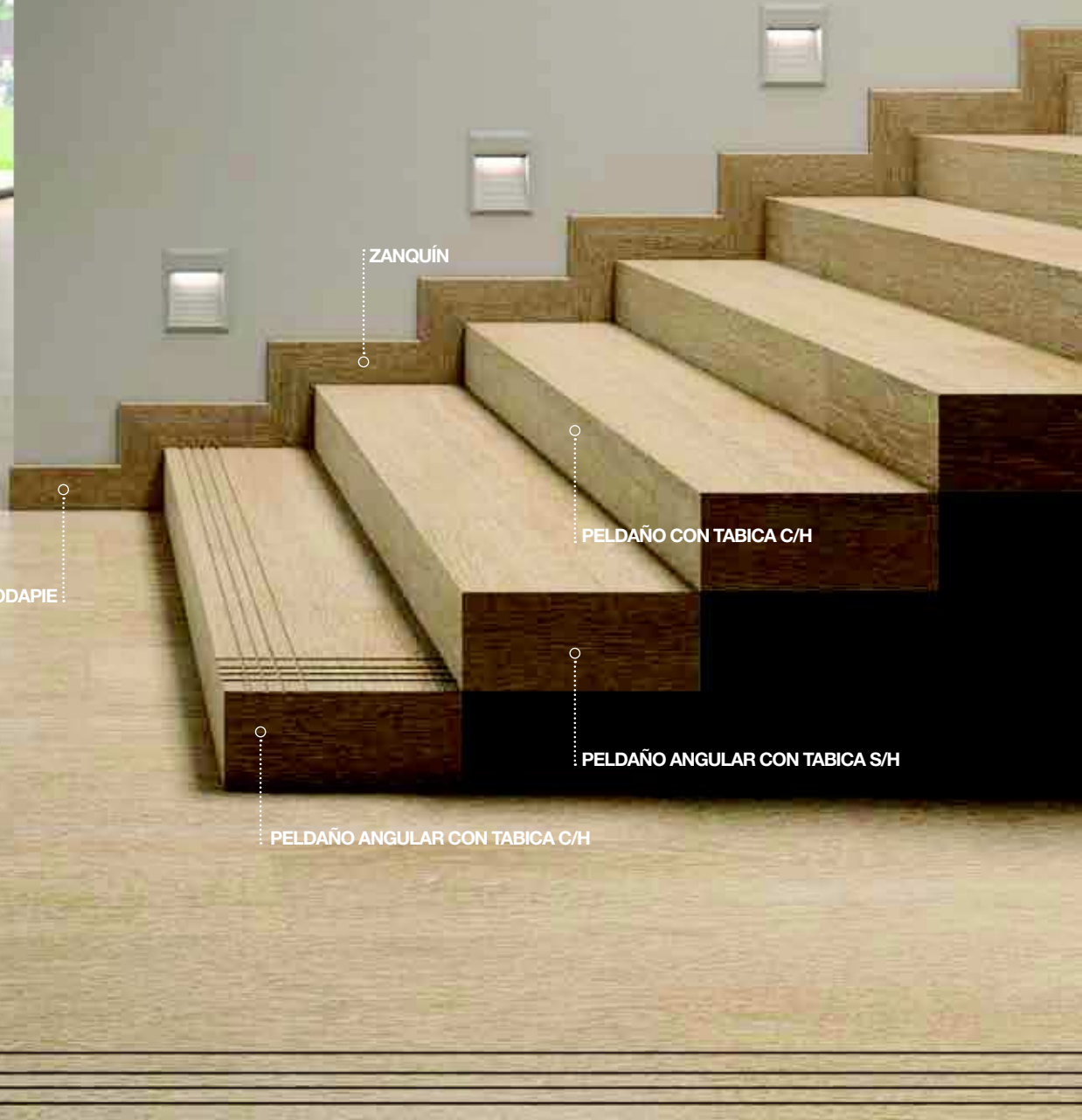

ZANQUÍN

PELDAÑO CON TABICA C/H

PELDAÑO ANGULAR CON TABICA S/H

PELDAÑO ANGULAR CON TABICA C/H

RODAPIE

PELDAÑO CON TABICA C/H

ENCIMERA A TRES LADOS  
(AGUJEROS  
OPCIONALES)

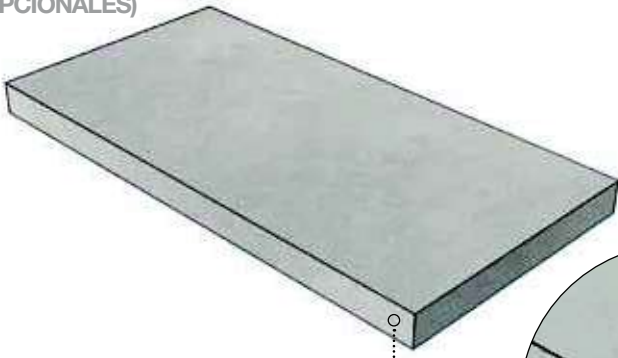

ENCIMERA FRONTAL  
(AGUJEROS  
OPCIONALES)



ENCIMERA FRONTAL  
MAS LATERAL  
IZQ. O DER.  
(AGUJEROS  
OPCIONALES)

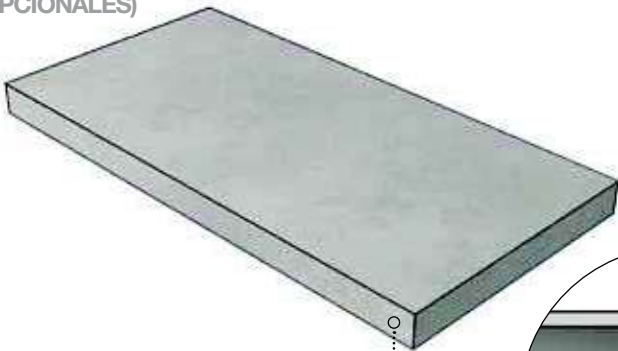

PLATO DE DUCHA

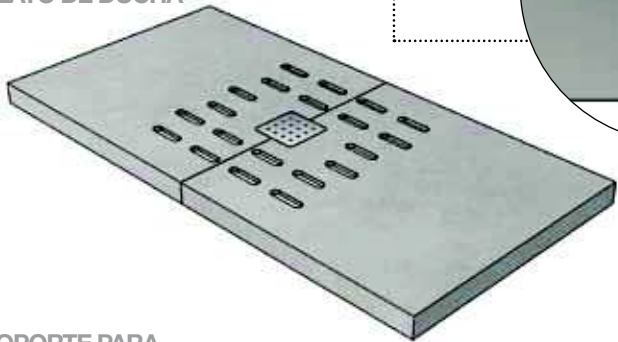

SOPORTE PARA  
ENCIMERA

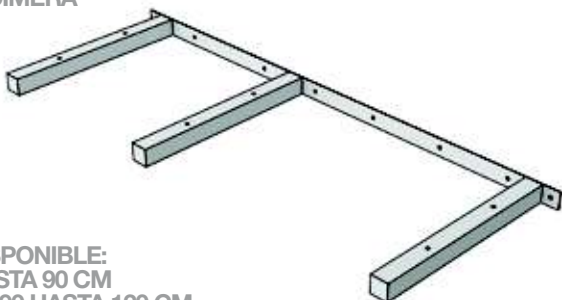

\*DISPONIBLE:  
\\HASTA 90 CM  
\\DE 90 HASTA 120 CM  
\\DE 120 HASTA 180 CM



ESTÁNDAR  
7 CM

MOSAICO 5X5 CM

PLATO DE DUCHA



# ENCIMERAS



ENCIMERA A TRES LADOS

**BORDE DE PISCINA  
FRONTAL**

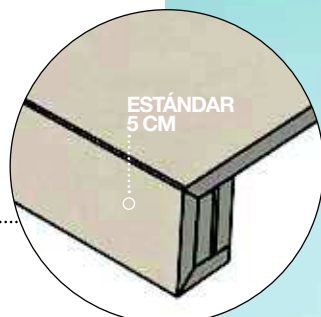
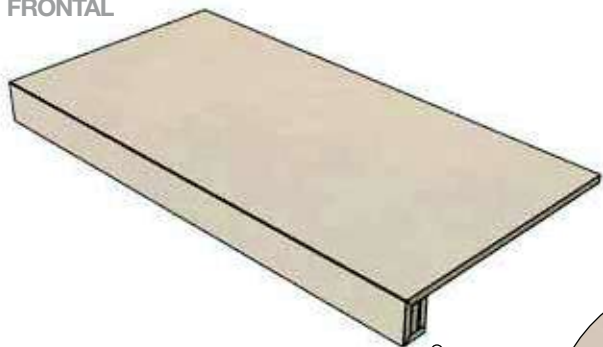

**BORDE DE PISCINA  
ANGULAR EXTERIOR  
IZQ. O DER.**



**BORDE DE PISCINA  
ANGULAR INTERIOR**

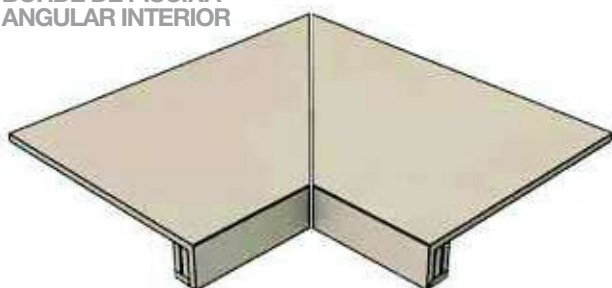

**REJILLA**

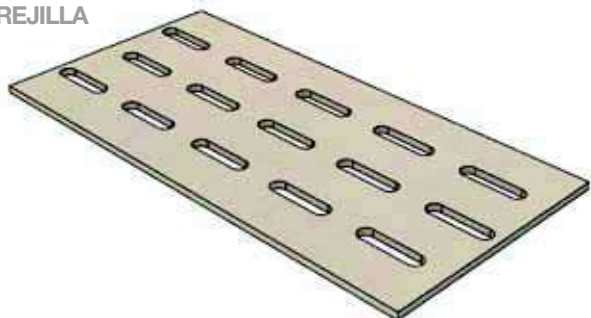

**BORDE DE PISCINA  
ANGULAR EXTERIOR**

**BORDE DE PISCINA FRONTAL**



# BORDE DE PISCINA



BORDE DE PISCINA  
ANGULAR INTERIOR

REJILLA

# FORMATOS



CORTE DE 60X120 CM A 30X120 CM

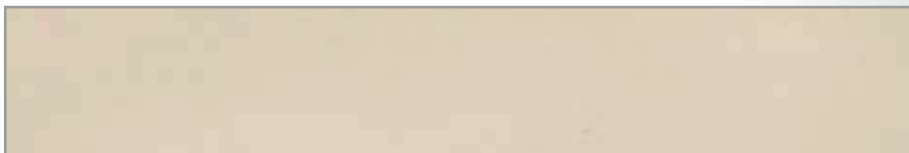

CORTE DE 60X120 CM A 20X120 CM



CORTE DE 60X120 CM A 15X120 CM



CORTE DE 60X60CM A 30X60 CM



CORTE DE 60X60CM A 20X60 CM



CORTE DE 60X60CM A 15X60 CM



CORTE DE 60X60CM A 10X60 CM



\* CONSULTAR PARA EL CORTE DE OTRAS MEDIDAS.





# SERVICIO DE CORTE



Mosaicos Safont S.L.  
Pol. Les Forques - Cno. Alcora, 103 -Apdo. 110  
Tel. 964 565 336 - Fax 964 565 337  
12550 Almazora (Castellón)  
España  
**pedidos@mosaicofont.com**  
**info@mosaicofont.com**  
**www.mosaicofont.com**